

BOX LINE Q

Centrífugos de baja presión





BOX LINE Q

Centrífugos de baja presión

Caja in-line con turbina centrífuga a reacción, aislada con panel sandwich. Dos versiones, Box Line Q para trasegar aire ambiente y Box Line Q HT para instalaciones de seguridad contra incendios según EN 12101-3 ("desenfumage") 400° 2 h.

CARACTERÍSTICAS

- Caja de chapa galvanizada.
- Rodete, álabes hacia atrás, en chapa galvanizada.
- Panel aislante de lana mineral de 50 mm de grosor con material aislante de densidad 70 kg/m³.
- Paneles intercambiables que permiten ubicar la descarga en cuatro laterales distintos.

Características específicas BOX LINE Q

- Motores con aislamiento clase F y protección IP55.

Características específicas BOX LINE Q HT

- Motores trifásicos clase H, IP55, certificados EN 12101-3, funcionamiento S1 y S2. Categoría EX II 3G Eex Na IIA T3.

Opciones:

- Conjuntos especiales según demanda.



Fabricamos soluciones
innovadoras

NOVOVENT

BOX LINE Q H

400V 50Hz (III~) 1.400 r.p.m. (n: min-1)

		m³/h	kW	Amp.	dB(A)	ERP2015				
						Q [m³/s]	Psf [Pa]	Pe [W]	η [%]	η ErP2015 [%]
BOX LINE Q 4-315T	BOXLQ4314	2.147	0,18	0,80	45	0,48	169	185	43,9	43,8
BOX LINE Q 4-350T	BOXLQ4350T	2.953	0,37	1,14	50	0,67	263	300	58,9	46,0
BOX LINE Q 4-400T	BOXLQ4400T	4.400	0,55	1,60	56	0,97	293	491	57,9	48,3
BOX LINE Q 4-450T	BOXLQ4450T	5.683	0,75	2,49	60	1,30	331	733	59,0	50,1
BOX LINE Q 4-500T	BOXLQ4500T	8.031	1,10	5,02	63	1,59	481	1.242	61,6	52,5
BOX LINE Q 4-560T	BOXLQ4560T	11.278	2,20	5,02	67	2,23	603	2.124	63,5	54,9
BOX LINE Q 4-630T	BOXLQ4630T	18.146	4,00	8,32	71	3,29	829	4.335	63,0	58,2
BOX LINE Q 4-710T	BOXLQ4710T	26.752	7,50	14,10	74	4,57	1.147	7.961	65,9	61,0
BOX LINE Q 4-800T	BOXLQ4800T	37.754	15,00	28,70	78	6,72	1.411	14.194	66,8	62,3

400V 50Hz (III~) 1.000 r.p.m. (n: min-1)

		m³/h	kW	Amp.	dB(A)	ERP2015				
						Q [m³/s]	Psf [Pa]	Pe [W]	η [%]	η ErP2015 [%]
BOX LINE Q 6-500T	BOXLQ6500T	5.354	0,37	1,91	54	1,05	219	452	50,6	47,9
BOX LINE Q 6-560T	BOXLQ6560T	7.518	0,75	2,93	58	1,45	280	712	57,0	50,0
BOX LINE Q 6-630T	BOXLQ6630T	12.097	1,10	3,91	62	2,19	369	1.392	58,1	53,0
BOX LINE Q 6-710T	BOXLQ6710T	17.834	2,20	6,25	65	3,05	510	2.517	61,8	55,7
BOX LINE Q 6-800T	BOXLQ6800T	25.169	4,00	9,96	69	4,48	627	4.513	62,3	58,4

BOX LINE Q HT

400V 50Hz (III~) 1.400 r.p.m. (n: min-1)

		m³/h	kW	Amp.	dB(A)
BOX LINE Q HT 4-315T	BOXLQHT4314T	2.147	0,18	0,80	45
BOX LINE Q HT 4-350T	BOXLQHT4350T	2.953	0,37	1,14	50
BOX LINE Q HT 4-400T	BOXLQHT4400T	4.400	0,55	1,60	56
BOX LINE Q HT 4-450T	BOXLQHT4450T	5.683	1,10	2,49	60

400V 50Hz (III~) 900 r.p.m. (n: min-1)

		m³/h	kW	Amp.	dB(A)
BOX LINE Q HT 6-560T	BOXLQHT6560T	7.518	1,10	2,93	58
BOX LINE Q HT 6-630T	BOXLQHT6630T	12.097	1,50	3,91	62
BOX LINE Q HT 6-710T	BOXLQHT6710T	17.834	2,20	6,25	65
BOX LINE Q HT 6-800T	BOXLQHT6800T	25.169	4,00	9,96	69

Banda de octavas

Hz	63	125	250	500	1000	2000	4000	8000
315	-6,5	-2,4	-9,0	-11,4	-15,4	-19,4	-23,4	-26,4
350	-6,5	-2,4	-9,1	-11,5	-15,5	-19,5	-23,5	-26,4
400	-6,6	-2,4	-9,3	-11,7	-15,8	-19,8	-23,7	-26,7
450	-6,6	-2,5	-9,4	-11,9	-16,6	-20,0	-23,9	-26,9
500	-6,8	-2,6	-9,7	-12,3	-16,4	-20,4	-24,3	-27,2
560	-6,8	-2,6	-9,7	-12,3	-16,4	-20,4	-24,3	-27,2
630	-7,1	-2,8	-10,4	-13,2	-17,4	-21,4	-25,2	-28,2
710	-7,3	-3,0	-10,8	-13,8	-18,0	-22,0	-25,8	-28,8
800	-7,6	-3,2	-11,4	-14,6	-18,8	-22,8	-26,6	-29,6

■ Dimensiones (mm)

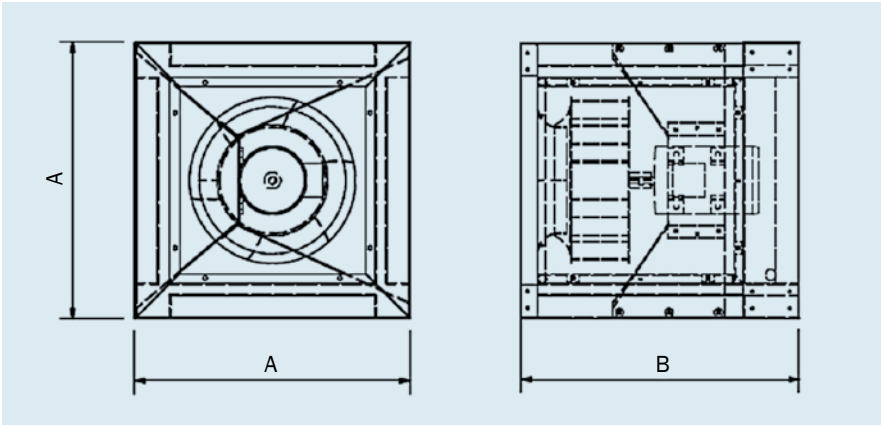

	Ø turbina	A	B
315	315	600	600
355	355	620	620
400	400	666	671
450	450	706	710
500	560	768	772
560	560	768	772
630	630	920	920
710	710	1000	1000
800	800	1099	1103

■ Curvas características

BOX LINE Q 4-315

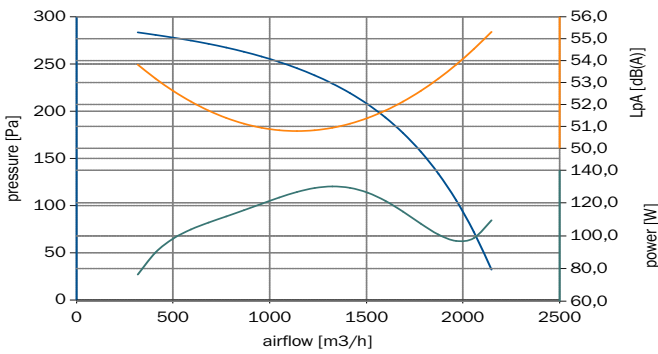

BOX LINE Q 4-355 PLUS

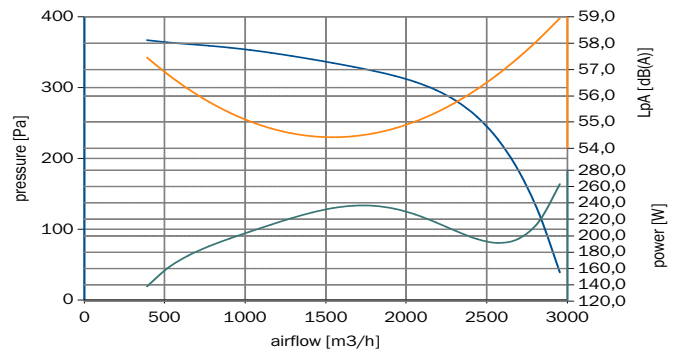

BOX LINE Q 125

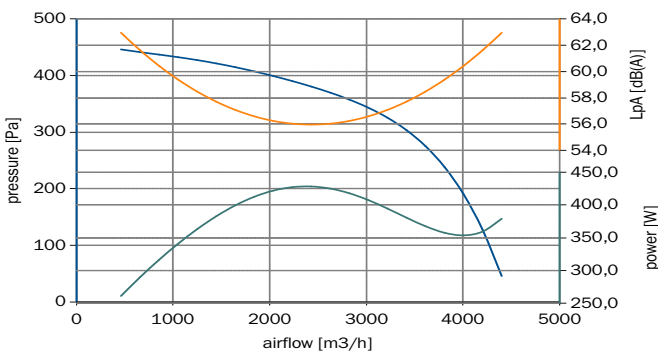

BOX LINE Q 125 PLUS

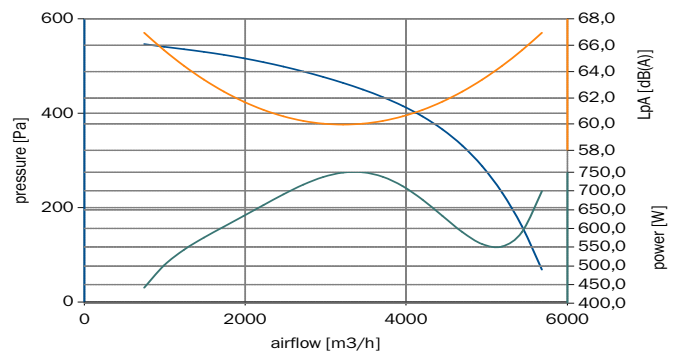

BOX LINE Q 150/160

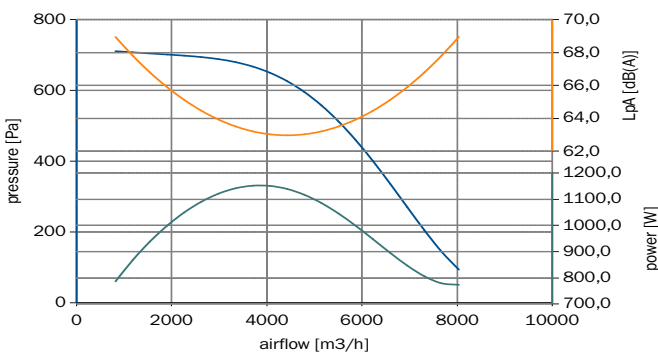

BOX LINE Q 150/160 PLUS

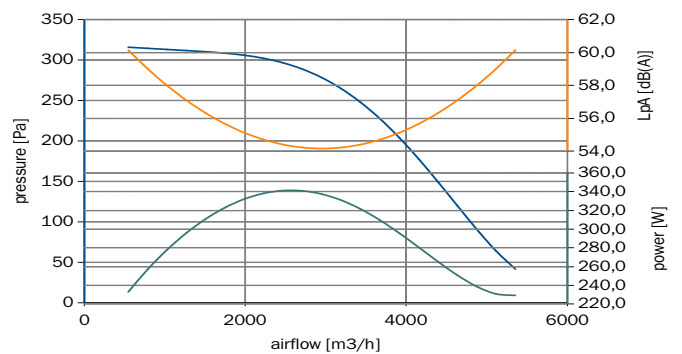

Curvas características

BOX LINE Q 200

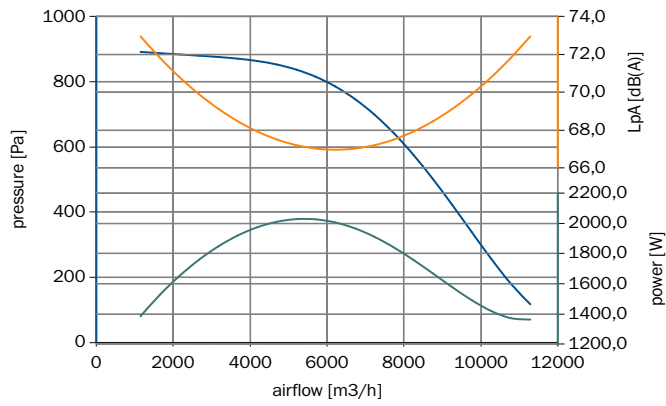

BOX LINE Q 200 PLUS

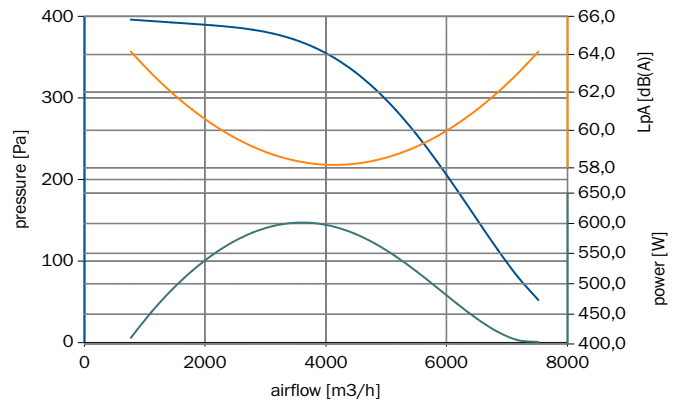

BOX LINE Q 100 EC

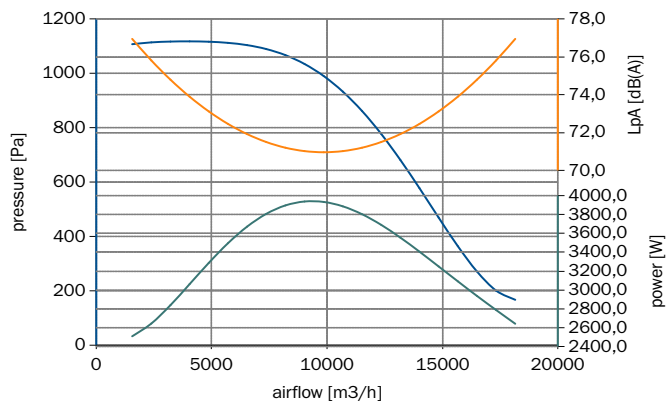

BOX LINE Q 100 EC PLUS

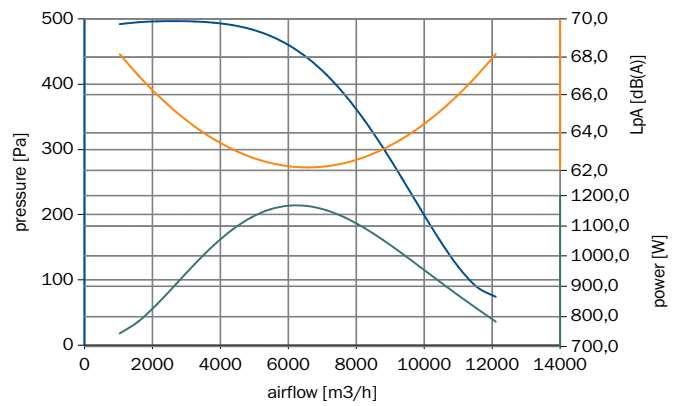

BOX LINE Q 125 EC

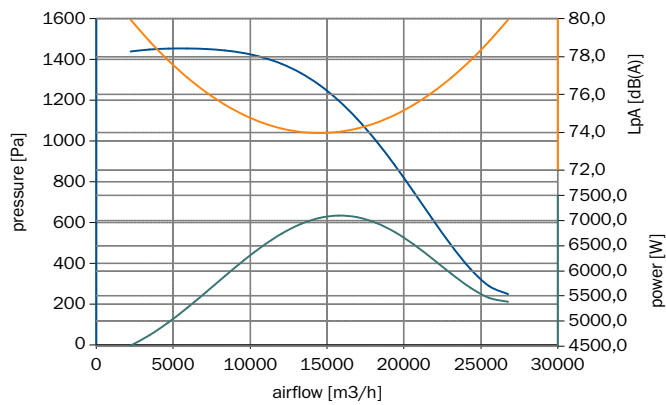

BOX LINE Q 125 EC PLUS

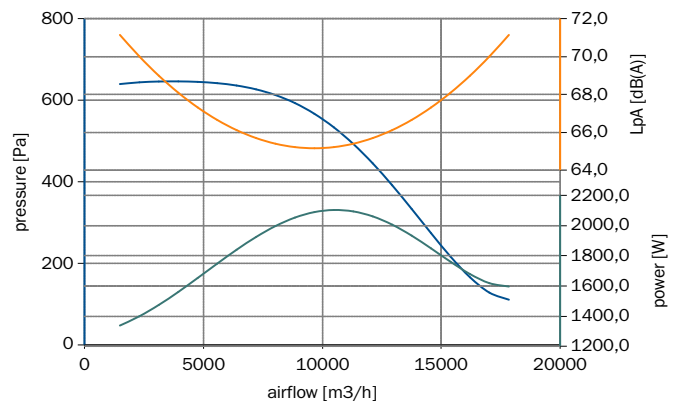

BOX LINE Q 150 EC

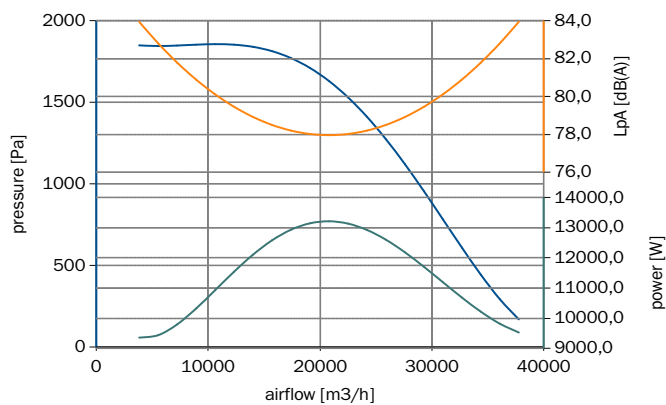

BOX LINE Q 150 EC PLUS

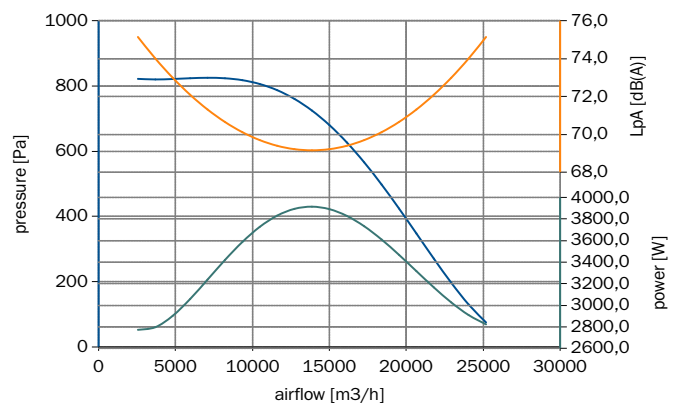



Fabricamos soluciones innovadoras

Josep Finestres, 9 · 08030 Barcelona · Tel. +34 93 278 82 77 · Fax +34 93 278 82 67
www.novovent.com · e-mail: novovent@novovent.com

